

INTIEL

THE ELECTRONICS ON YOUR SIDE

Programmable Time Relay
INT0010

User's Guide

I. Application

The Time Relay INT0010 is designed to control electrical circuits as time-delay or tact relay. It has six programmable functions and three time intervals: 0-99 seconds, 0-99 minutes, 0-99 hours.

II. Indication and buttons

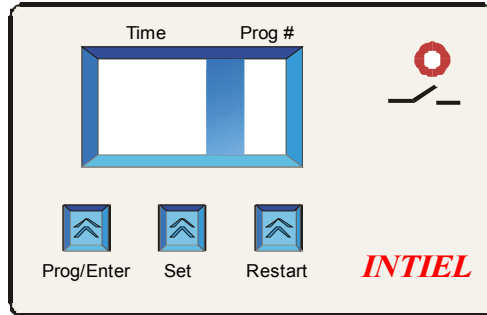

1. **"Time"** indication – two sectional digital display, showing the time from 00-99.
2. **"Prog #"** indication – one sectional digital display, showing the program number in the range of 1-5 and time unit measurement as: **11** - seconds; **1** - minutes; **h** - hours
3. Indication  shows a switched on relay.
4. **"Prog/Enter"** button – shows entering in a program regime and a data input one.
5. **"Set"** button – selects a program, time period and time interval in program regime.
6. **"Restart"** button – starts the selected program.

III. Functions and programming

Program 1. Single cycle of time-delay period. The program starts after providing a power supply U to the Relay. It delays passing the consumer voltage U_z in accordance with the preliminary fixed time T , after that the Relay is being started, providing voltage to the consumer, keeping that position until the supply voltage will be discharged. The start input is not being used.

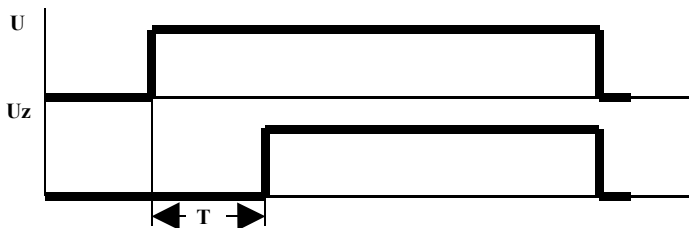

Programming:

- Press button "**Prog/Enter**" – indication "**Prog #**" blinks and a long sound signal can be heard.
- Keep pressing "**Set**" button until indication **1** starts blinking
- Press button "**Prog/Enter**" to input the program number. On the indication "**Prog #**" starts blinking a symbol for the time period.
- Press button "**Set**" until select the desired time period:
 11 - seconds; l - minutes; **h** - hours
- Press button "**Prog/Enter**" to input the selected time period. On the "**Time**" indication starts blinking the first time period.
- Press button "**Set**" until select the desired value from 0 - 9
- Press button "**Prog/Enter**" to input the desired value. On "**Time**" indication starts blinking the second time period.
- Keep pressing "**Set**" button until select the desired value from 0 - 9
- Press button "**Prog/Enter**" to input the selected value. On "**Prog #**" indication starts blinking the number of the selected program - 1.
- Press button "**Prog/Enter**" to activate program - 1. "**Prog #**" indication stops blinking and three short sound signals can be heard.
- Press button "**Restart**" to start program 1. After it starting "**Time**" point indication start blinking, showing the remaining time.

Program 2. Single cycle with a time-delay period. Fix the time-delay period of the provided voltage to a consumer. It starts after providing a voltage **U** to the Relay supply terminals. The voltage to the consumer is being discharged after the end of the time-delay period **T**. Program 2 is inversely to program 1.

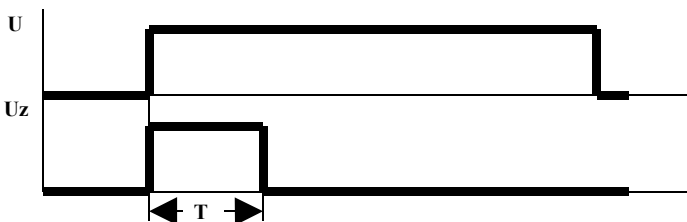

Programming:

- Press button "**Prog/Enter**" - "**Prog #**" indication blinks and a long sound signal can be heard
- Keep pressing "**Set**" button until number 2 starts blinking
- Press button "**Prog/Enter**" to input the number of the program. On "**Prog #**" indication starts blinking a symbol showing the time period.
- Keep pressing "**Set**" button until select the desired time period:
 11 - seconds; l - minutes; **h** - hours

- Press button "**Prog/Enter**" to input the selected time period. On "**Time**" indication starts blinking the first section.
- Keep pressing "**Set**" button until select the desired value from 0 up to 9
- Press button "**Prog/Enter**" to input the chosen value. On "**Time**" indication starts blinking the second section.
- Keep pressing "**Set**" button until select the desired value from 0 up to 9.
- Press button "**Prog/Enter**" to input the chosen value. On "**Prog #**" indication starts blinking the number of the input program – 2.
- Press button "**Prog/Enter**" to activate program 2. "**Prog #**" indication stops blinking and three short sound signals can be heard.
- Press button "**Restart**" to start program 2. After program starting a point of "**Time**" indication starts blinking, showing the remaining time.

Program 3. Single cycle with a time-delay period. It is used for providing a voltage to a consumer U_z and a time-delay period T after closing a support contact (button). It starts with closing the support contact after providing a support voltage U to the Relay. After the time starting, the position of the support contact is not of any importance. In the end of the time-delay period T the voltage to the consumer is being discharged. New time-delay period T can be started only after closing the support contact once again.

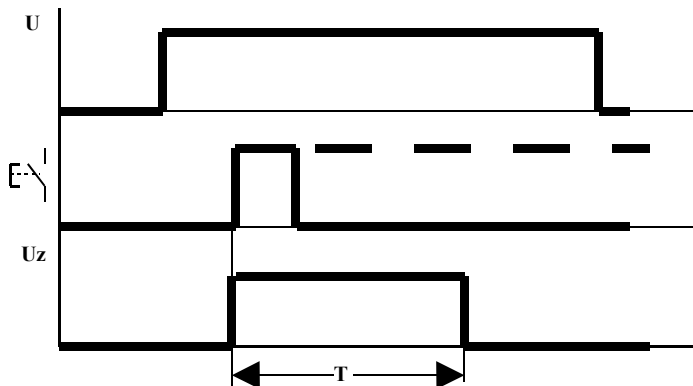

Programming:

- Press button "**Prog/Enter**" - "**Prog #**" indication blinks and a long sound signal can be heard.
- Keep pressing "**Set**" button until number 3 starts blinking
- Press button "**Prog/Enter**" to input the number of the program. On "**Prog #**" indication a symbol of a time period starts blinking.

- Keep pressing "Set" button until select the desired time period:
 11 - seconds; 1 - minutes; h - hours
- Press button "Prog/Enter" to input the chosen time period. On "Time" indication the first section starts blinking.
- Keep pressing "Set" button until select the desired value from 0 up to 9.
- Press button "Prog/Enter" to input the chosen value. On "Time" indication the second section starts blinking
- Keep pressing "Set" button until select the desired value from 0 up to 9.
- Press button "Prog/Enter" to input the chosen value. On "Prog #" indication starts blinking the number of the input program – 3.
- Press button "Prog/Enter" to activate program 3. "Prog #" indication stops blinking and three short sound signals can be heard.
- Press button "Restart" to start program 3. The program waits for closing the outer contact between terminals 23 and 24. After the contact closing the point of "Time" indication starts blinking, showing the remaining time.

Program 4. Single cycle with a time-delay period. It delays the consumer voltage discharge U_z with a support contact opening, after providing a support voltage U to the Relay. The time-delay period T starts, when the support contact will be opened. The consumer voltage is provided after closing the support contact and it is discharged in the end of the time-delay period T .

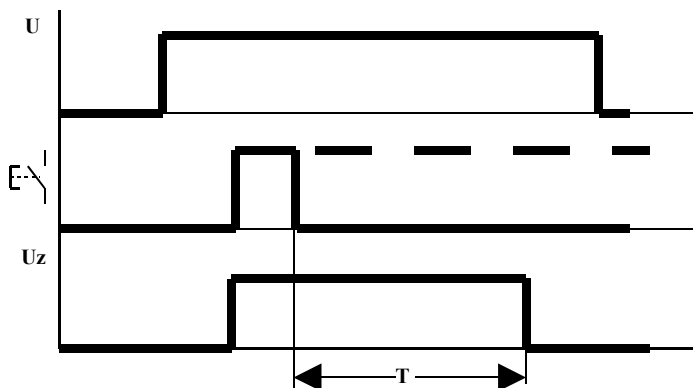

Programming:

- Press button "Prog/Enter" - "Prog #" indication blinks and a long sound signal can be heard.
- Keep pressing "Set" button until the number 4 starts blinking.

- Press button "**Prog/Enter**" to input the number of the program. On "**Prog #**" indication a symbol of a time period starts blinking.
- Keep pressing "**Set**" button until select the desired time period:
 $^{\text{1}}$ - seconds; $^{\text{1}}$ - minutes; $^{\text{h}}$ – hours.
- Press button "**Prog/Enter**" to input the chosen time period. On "**Time**" indication a first section starts blinking.
- Keep pressing "**Set**" button until select the desired value from 0 up to 9.
- Press button "**Prog/Enter**" to input the chosen value. The second section on "**Time**" indication starts blinking.
- Keep pressing "**Set**" button until select the desired value from 0 up to 9
- Press button "**Prog/Enter**" to input the chosen value. On "**Prog #**" indication starts blinking the number of the input program – 4.
- Press button "**Prog/Enter**" to activate program 4. "**Prog #**" indication stops blinking and three short signals can be heard.
- Press button "**Restart**" to start program 4. The program waits for outer contact closing between terminals 23 and 24. After contact opening the point of "**Time**" indication starts blinking, showing the remaining time.

Program 5. Repeatable cycle of time-delay period. It periodically fixes the time-delay period after providing and discharging of the consumer voltage for different and repeatable time periods. The cycle with a time-delay period starts with providing a power supply U to the Relay. Providing a voltage to the consumer is being done for a fixed time $T1$ and afterwards it is being discharged for fixed time $T2$. This cycle is being used until the Relay voltage will be discharged. The Relay start input is not being used.

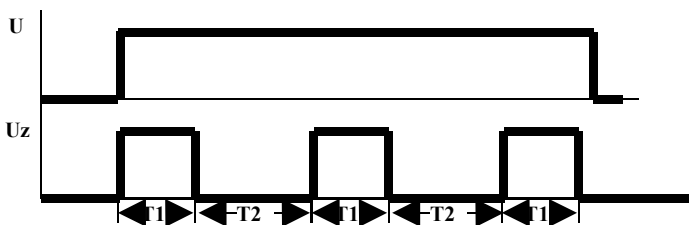

Programming:

- Press button "**Prog/Enter**" - "**Prog #**" indication blinks and a long sound signal can be heard.
- Keep pressing "**Set**" button until the number 5 starts blinking.
- Press button "**Prog/Enter**" to input the program number. On "**Prog #**" indication start blinking the symbol of the time for a switched on state $T1$.

- Press button "**Prog/Enter**" to input the switched on state. On "**Prog #**" indication start blinking a symbol for a time \square period.
- Keep pressing "**Set**" button until select the desired time period:
 '' - seconds; ' - minutes; h – hours.
- Press button "**Prog/Enter**" to input the selected time period. On "**Time**" indication the first section starts blinking.
- Keep pressing "**Set**" button until choose the desired value from 0 up to 9
- Press button "**Prog/Enter**" to input the chosen value. The second section on "**Time**" indication starts blinking.
- Keep pressing of "**Set**" button until choose the desired value from 0 up to 9.
- Press button "**Prog/Enter**" to input the chosen value. On "**Prog #**" indication a symbol of the time for switched off state \sqcup starts blinking.
- Press button "**Prog/Enter**" to input switched off state. A symbol of time period on "**Prog #**" indication starts blinking.
- Keep pressing of "**Set**" button until select the desired time period:
 '' - seconds; ' - minutes; h – hours.
- Press button "**Prog/Enter**" to select the desired time period. The first section on "**Time**" indication starts blinking.
- Keep pressing of "**Set**" button until select the desired value from 0 up to 9.
- Press button "**Prog/Enter**" to input the chosen value. The second section on "**Time**" indication starts blinking.
- Keep pressing of "**Set**" button until select the desired value from 0 up to 9.
- Press button "**Prog/Enter**" to input the chosen value. On "**Prog #**" indication starts blinking the number of selected program - 5.
- Press button "**Prog/Enter**" to activate program 5. "**Prog #**" indication stops blinking and three short sound signals can be heard.
- Press button "**Restart**" to start program – 5. After the program starting a point on "**Time**" indication starts blinking, showing the remaining time.

Program 0. It stops the consumer voltage U_z if a supply voltage U is available.

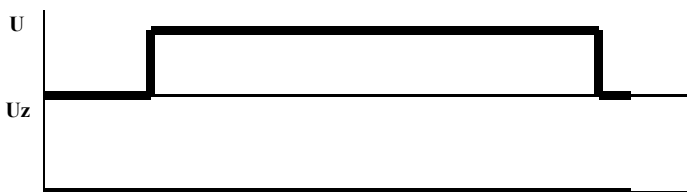

Programming:

- Press button "**Prog/Enter**" - "**Prog #**" indication starts blinking and a long sound signal can be heard.
- Keep pressing of "**Set**" button until the number 0 starts blinking.

- Press button "**Prog/Enter**" to activate program **0**. "**Prog #**" indication stops blinking and three short sound signals can be heard.

IV. Wiring:

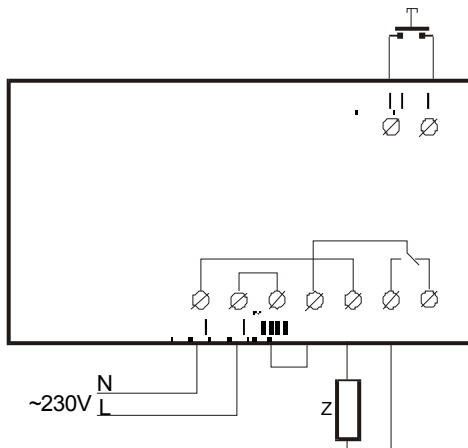

On the above mentioned figure is shown an example wiring scheme, where the consumer **Z** operates with a voltage of $\sim 230\text{V}$. The bridge between terminals 8 and 9 should not be placed, when the consumer operates with a different voltage than $\sim 230\text{V}$.

To terminals 23 and 24 is to be connected a contact for starting, when a program **3** and **4** are being used. To the same terminals should not be connected anything concerning all the rest Relay programs.

V. Warranty

The warranty period is 24 months following the purchase date of the unit or its installation by an authorized Engineering Company, but not exceeding 28 months after the production date. The warranty is extended to the malfunctions that occur during the warranty period and are result of the production reasons or defective used parts.

The warranty does not relate to malfunctions corresponding to not-qualified installation, activities directed to the product body interference, not regular storage or transport.

The repairs during the warranty period can be done after correct filling of the manufacturer warranty card.

Warranty Card

Manufacturer: INTIEL	
Product type	Programmable Time Relay INT0010
Production number	
Production date	
Dealer confirmation	
Purchase date	
Invoice number	
Dealer's name, address and stamp	
Seller's name and signature	
Installation Date	
Date	
Company (address, stamp)	
Installer's name and signature	